

LAYOUT RECORD-S SX 4000 MULTIPIANO BASSO

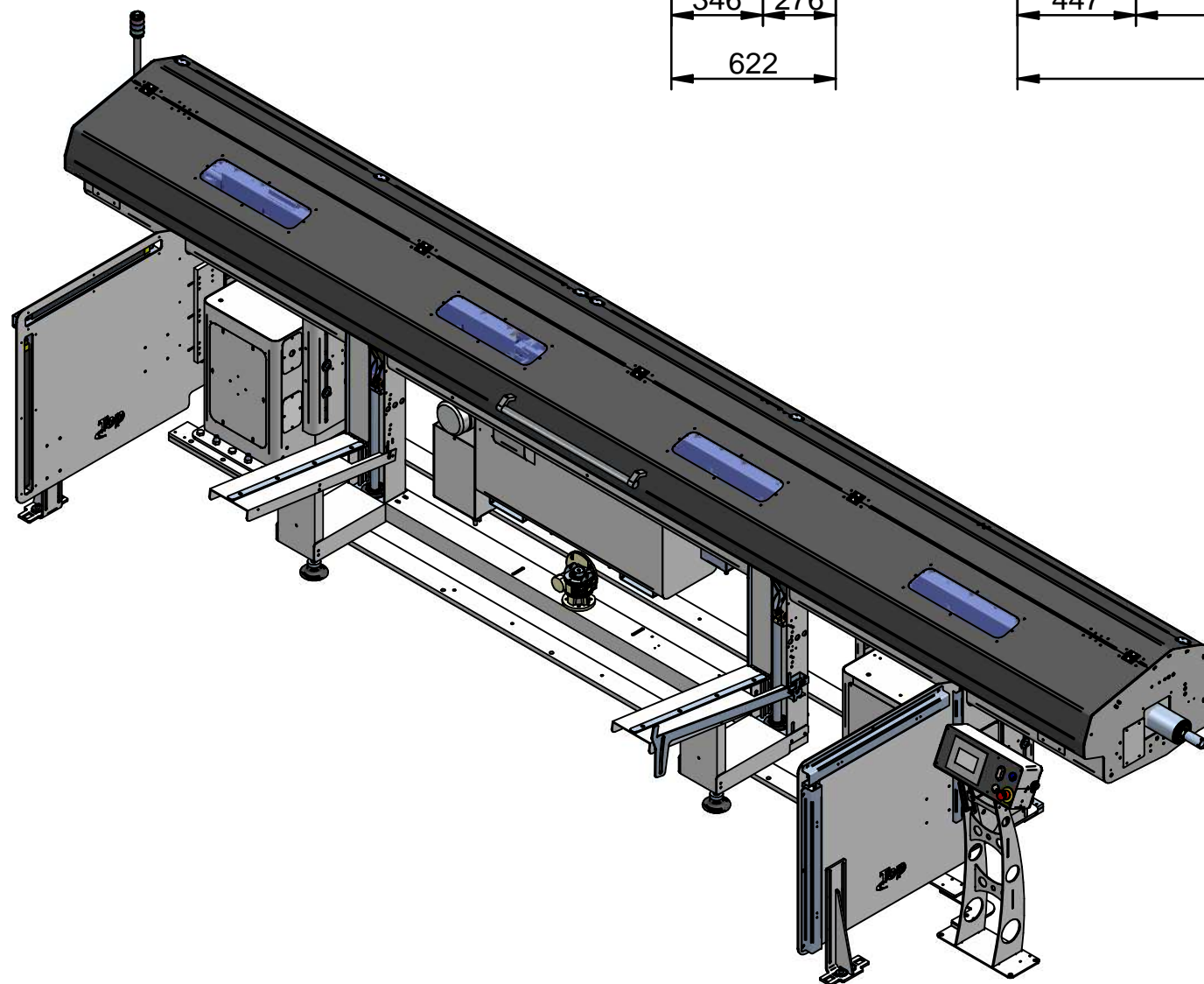
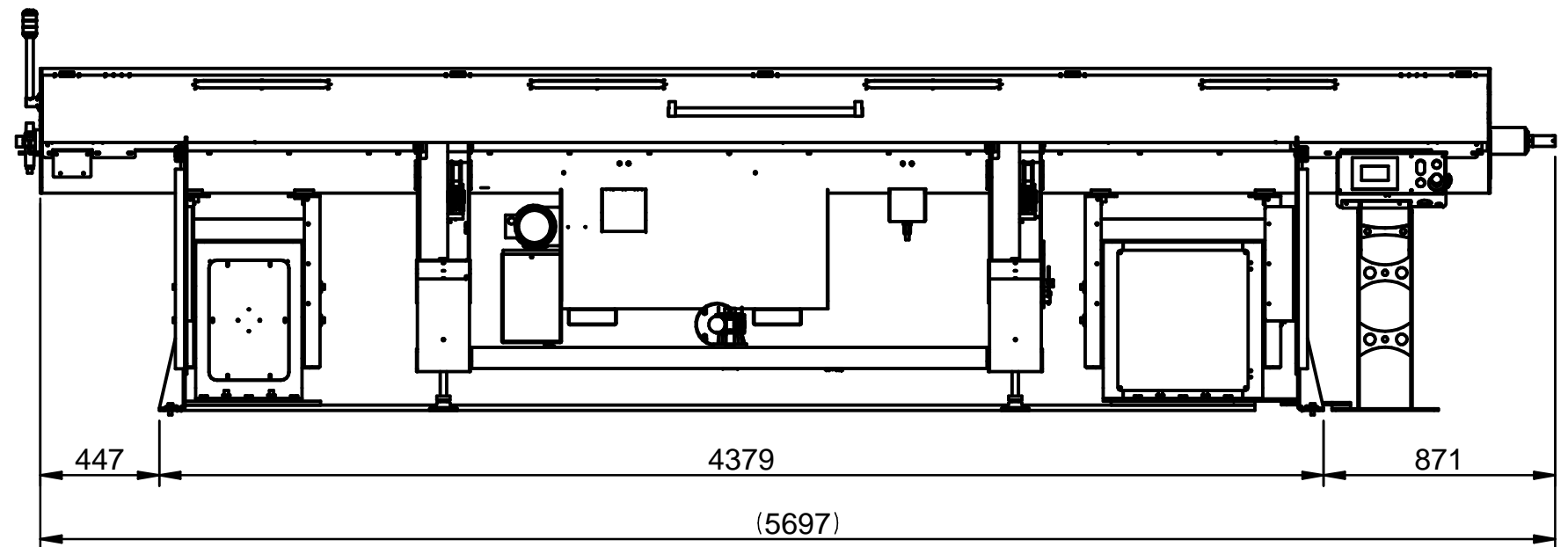
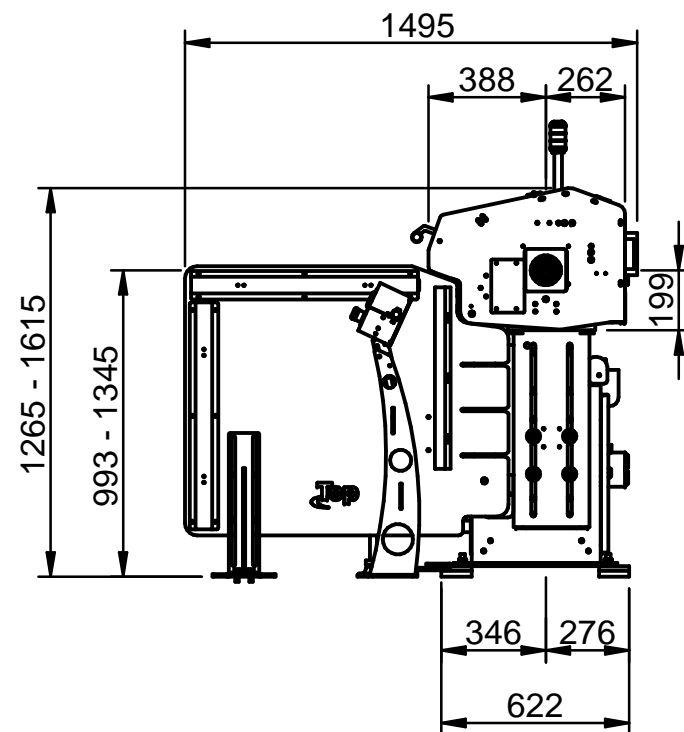

CARATTERISTICHE TECNICHE / TECHNICAL DATA

DIAMETRO BARRA LAVORABILE Bar Diameter Range	Min. Ø 4mm - Max. Ø 45mm Min. Ø 0,16" - Max. Ø 1,77"
TENSIONI DI ALIMENTAZIONE Operating Voltage	230 V Trifase 50 Hz Three Phase
VELOCITA' DI AVANZAMENTO Feeding Speed	0 - 500 mm/sec. 0 - 19,68"/sec.
OLIO LUBRIFICANTE GUIDE Guide Channel Lubrificant	ISO VG 68
ARIA COMPRESSA RICHIESTA Required Air Pressure	7 bar
PESO Weight	2200Kg 4850 lb
LUNGHEZZA MAX BARRA LAVORABILE Maximum Bar Length	4100 mm 13,45 ft