

LAYOUT MATRIX SX 4000 MONOPIANO

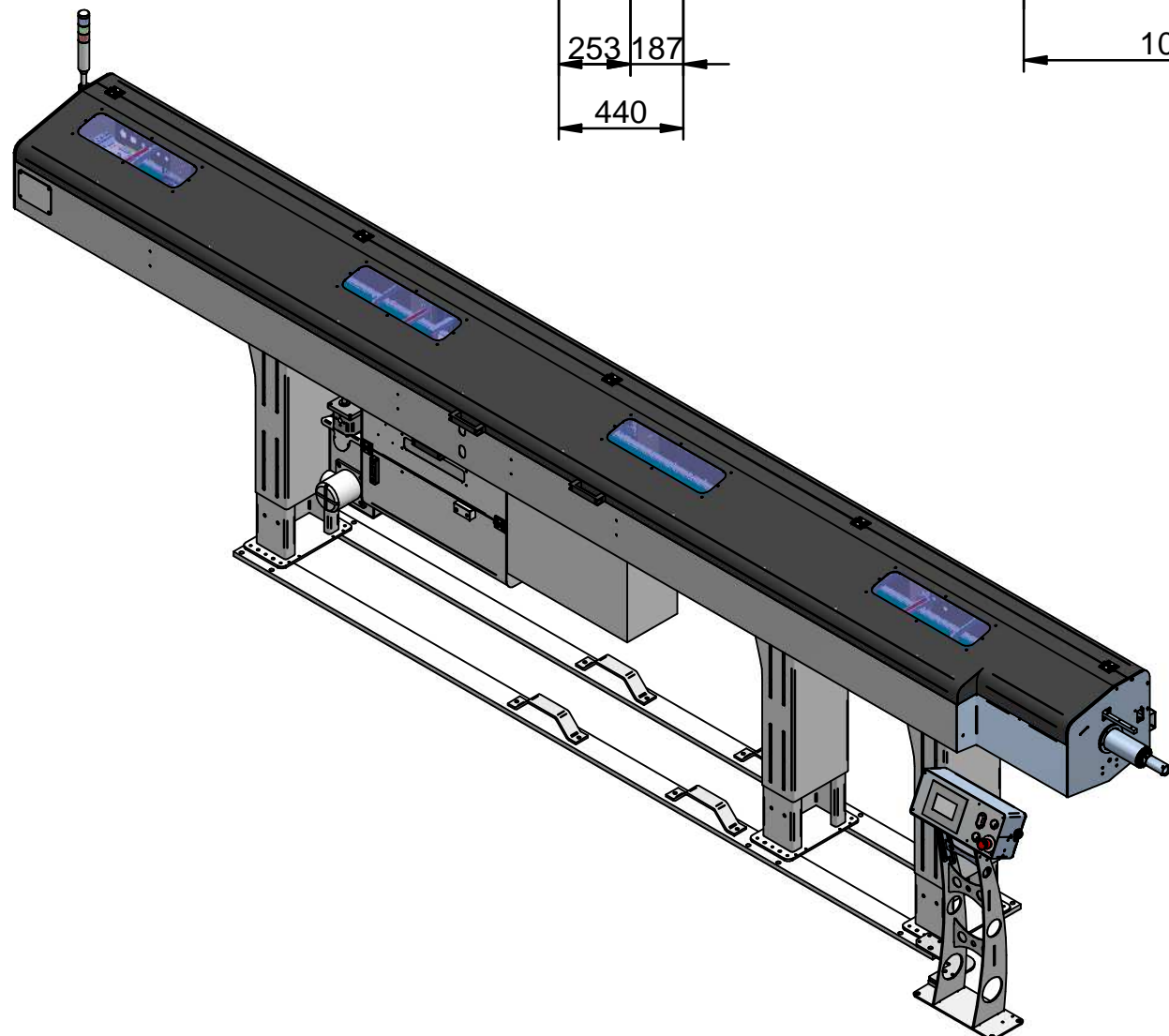
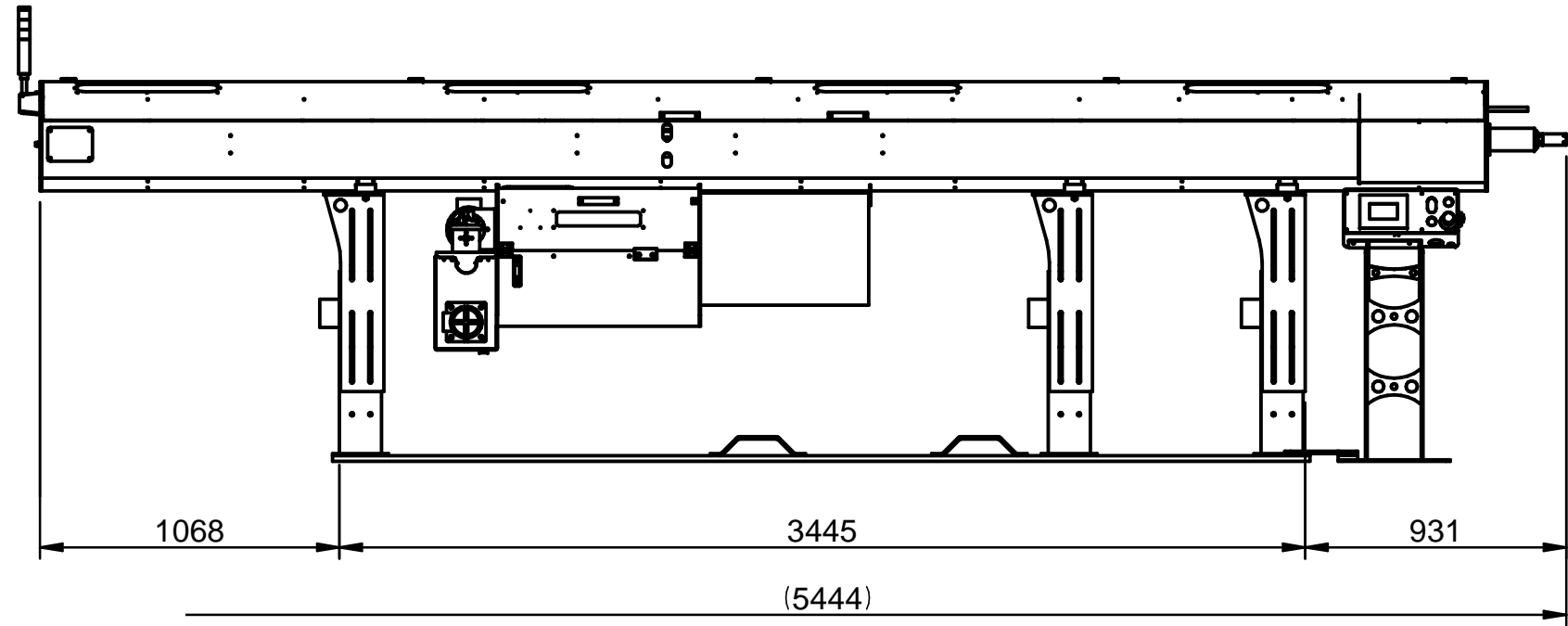
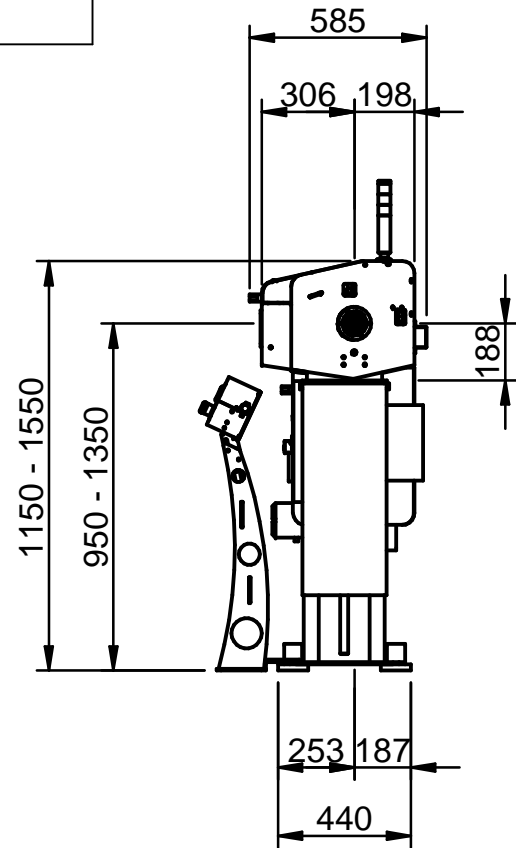

CARATTERISTICHE TECNICHE / TECHNICAL DATA

DIAMETRO BARRA LAVORABILE Bar Diameter Range	Min. Ø 3mm - Max. Ø 25mm Min. Ø 0,11" - Max. Ø 0,98"
TENSIONI DI ALIMENTAZIONE Operating Voltage	230 V Trifase 50 Hz Three Phase
OLIO LUBRIFICANTE GUIDE Guide Channel Lubrificant	ISO VG 68
ARIA COMPRESSA RICHIESTA Required Air Pressure	7 bar
PESO Weight	1500 Kg 3307 lb
LUNGHEZZA MAX BARRA LAVORABILE Maximum Bar Length	4100 mm 13,45 ft